

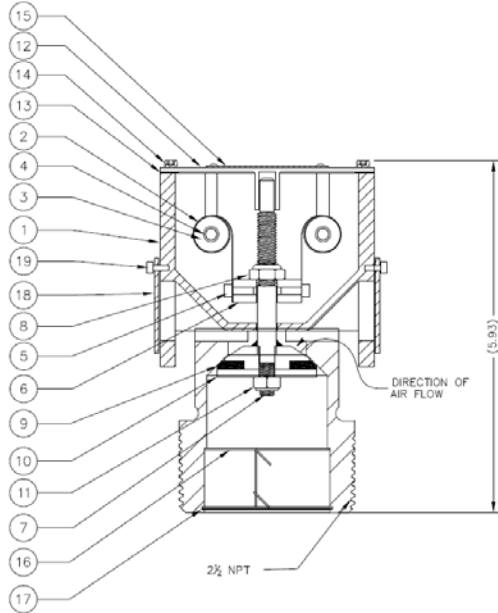

Vacuum Relief Valve Threaded KVR3.0S



Valve Model	KVR3.0S
Set Pressure (psig – vacuum)	3.0
Orifice Diameter (in)	1.28
Flow Area (sq. in)	1.28
Weight (lbs)	6
Height (in)	5.93
Connection	2 ½ NPT
Number of Springs	2

			KVR3.0S
			E152103
ITEM #	QTY.	AAR Approval Number	MATERIAL
		DESCRIPTION	
1	1	Body Assy.	Stainless Steel
2	2	1" Single Spring	301 SS
3	2	Drum	Nylon
4	2	Drum Shaft	304 SS
5	2	Spring Screw	18-8 SS
6	1	Spring Block	304 SS
7	1	Adjustment Screw Assy.	316 SS
8	1	Jam Nut	18-8 SS
9	1	Seal	Varies
10	1	Seal Retainer	316 SS
11	1	Seal Retainer Jam Nut	316 SS
12	1	Cover	304 SS
13	1	Cover Seal	Elastomeric
14	4	Cover Screw	18-8 SS
15	1	Nameplate	Aluminum
	2	Nameplate Rivets (not shown)	18-8 SS
16	1	Baffle (optional)	316 SS
17	1	Retainer Ring	316 SS
18	2	View Port Cover	304 SS
19	2	Allen Head Screw	304 SS

Patent No. - 9,441,749

Stainless Steel Body composition – 316L

Seal material composition based on specification

Other Sealing options available

Note: Mounting flange gasket not supplied

*Under Service Trial – ST 456