

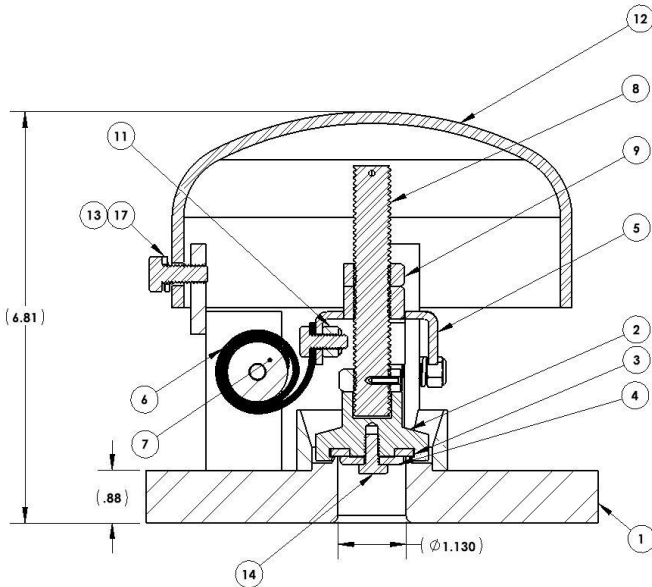

Pressure Relief Valve JS165LT & JS165LTS 3-Hole Mounting Flange

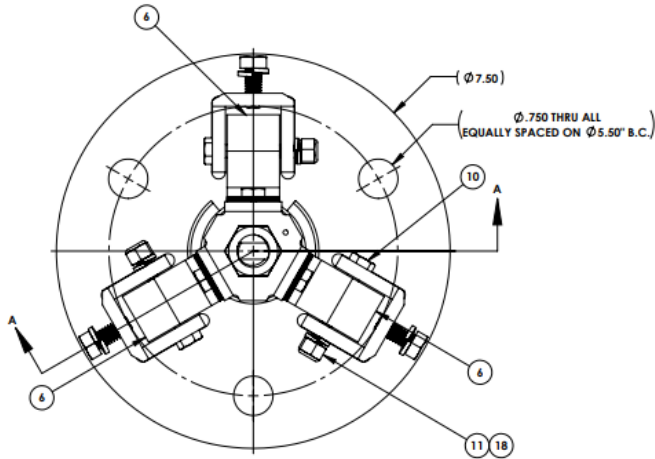

ATTRIBUTES	
Set Pressure (psig)	165
Flow Rate (SCFM-Air)	3445 @182 psi
Orifice Diameter (in)	1.13
Flow Area (sq. in)	1
Weight (lbs)	18
Height (in)	6.81
Flange Thickness (in)	0.88
Number of Bolt Holes	3
Bolt Hole Size (in)	0.75
Bolt Circle (in)	5.50
Interface Options	Tongue & Groove, Raised or Flat Faced
Number of Springs	18
Max % of Spring Bolt Shear	4

Notes:

- AAR Approval Number: PRV-119027
- Material Compositions: Carbon - A516 Grade 70, Stainless – 316L
- Other options available – see document KTUD 1306 (PRV Naming Convention)
- Seal Material composition based on specification
- ** Various seal materials available
- Mounting flange gaskets not supplied unless specified

ITEM NO.	QTY.	DESCRIPTION	MATERIAL	
			JS165LT	JS165LTS
1	1	BODY ASSEMBLY	CARBON STEEL	STAINLESS STEEL
2	1	SEALING DISC	316 STAINLESS STEEL	316 STAINLESS STEEL
3	1	SEAL	ELASTOMER**	ELASTOMER**
4	1	SEAL RETAINER PLATE	316 STAINLESS STEEL	316 STAINLESS STEEL
5	1	SPRING BLOCK	CARBON STEEL	STAINLESS STEEL
6	3	6 LAMINATION SPRING - 1"	301 SS	301 SS
7	3	SPRING DRUM	NYLON 6/6	NYLON 6/6
8	1	ADJUSTMENT SCREW	ALLOY STEEL	STAINLESS STEEL
9	1	5/8-11 HEX JAM NUT	18-8 SS	18-8 SS
10	3	1/4-20 X 2 HEX CAP SCREW	18-8 SS	18-8 SS
11	6	1/4-20 NE NYLON INSERT LOCK NUT (WAXED)	18-8 SS	18-8 SS
12	1	DOME COVER	ASTM A414G STEEL	ASTM A414G STEEL
13	3	HEX BOLT, 5/16-18 X 3/4 , GRADE 5, ZINC PLATED	CARBON STEEL	CARBON STEEL
14	1	1/4-20 X 1/2 HEX CAP SCREW	316 STAINLESS STEEL	316 STAINLESS STEEL
17	3	5/16" SPLIT LOCK WASHER, GRADE 8, ZINC PLATED	ALLOY STEEL	ALLOY STEEL
18	3	1/4" SPLIT LOCK WASHER	ALLOY STEEL	ALLOY STEEL

© 2022 Kelso Technologies (USA) Inc. All Kelso Angle Valves Patent Protected. Detailed designs are subject to change without notice, detailed drawings available upon request.
Kelso Technologies Inc. 1526 Texas Ave, Bonham, Texas 75418, Phone: (903) 583-9200